

# HAKI Suspension Devices

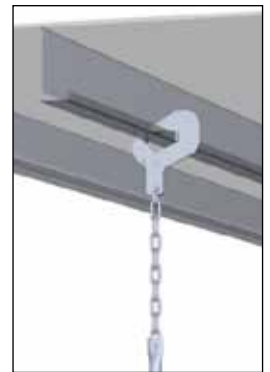
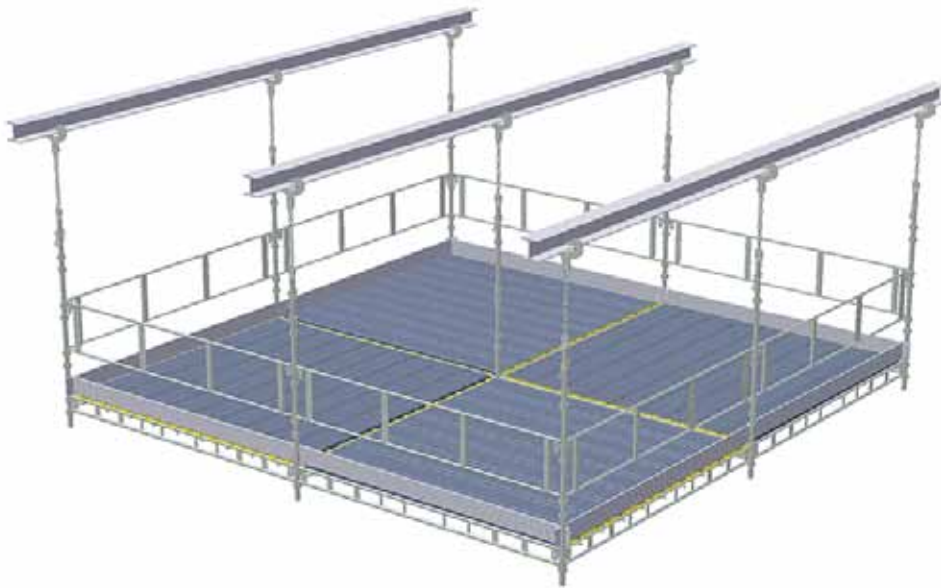

**HAKI Suspension devices** make it possible to suspend scaffolding from virtually any load-bearing structure.

HAKI's many years of experience of scaffolding construction in the offshore and shipbuilding industry have resulted in a unique range of suspension devices.

In order to be capable of bearing tensile loads, the standard joints of the suspended scaffolding must be locked using 16 mm locking pins.

PLEASE NOTE: All suspended scaffold structures must be anchored or diagonally braced at the sides and be braced using horizontal diagonal braces in order to be capable of withstanding any lateral forces from, for example, wind load. The nodes between horizontal and vertical elements may otherwise be damaged and in the worst case fail.

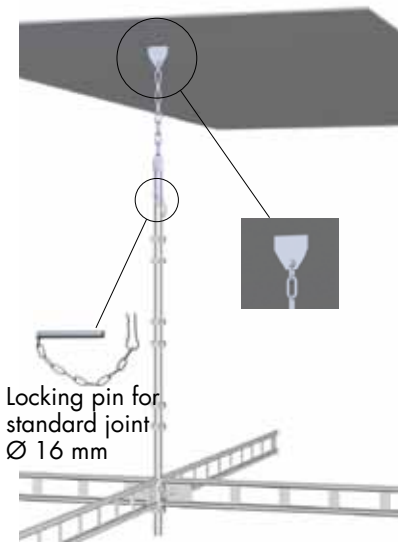

Locking pin for  
standard joint  
Ø 16 mm



### Suspension device chain

Available in two versions with construction heights 1362 and 850 mm.

The device can be adjusted in height in 64 mm stages by moving the shackle in the chain.

Used for suspending a standard in another suspension device or in a welding lug or similar.

Welding lugs or similar must be capable of bearing a load of 40 kN and be suitable for shackle 6130251.

Permissible load 20.0 kN. PLEASE NOTE: The permissible load is much reduced when the load is at an angle to the standard and with increased distance to the first beam node. Please contact HAKI's technical department for information.

When the angle of deviation between the load and the line of the standard is large and when fixing further down the standard, use the KF 48 double suspension device 7175101 combined with chain and shackle.



### Clamp H-beam 80-180

Designed for H-beam with flange width 80-180 mm, flange thickness max 35 mm and thickness of web max 16 mm.

### H-beam 150-300

Designed for H-beam with flange width 150-300 mm, flange thickness max 35 mm and thickness of web max 20 mm.

Used in combination with chain suspension device 7175001 or 7175002.

Permissible load 20.0 kN.



### Clamp H-beam 300-450

Designed for H-beam with flange width 300-450 mm, flange thickness max 35 mm and thickness of web max 20 mm.

Used in combination with chain suspension device 7175001 or 7175002.

Permissible load 20.0 kN.



### Clamp L-beam 60-120

Designed for L-beam with flange width 60-120 mm, flange thickness max 35 mm and thickness of web max 15 mm.

Used in combination with chain suspension device 7175001 or 7175002.

Permissible load 20.0 kN.



**Clamp bulb iron chain 160x9-200x12**

Designed for bulb flats (Holland profile) 160x9-200x12 mm.

**Clamp bulb iron chain 220x10-300x13**

Designed for bulb flats (Holland profile) 220x10 - 300x13 mm.

**Clamp bulb iron chain 320x11.5-370x16**

Designed for bulb flats (Holland profile) 320x11.50 - 370x16 mm.

Used in combination with chain suspension device 7175001 or 7175002.

Permissible load 20.0 kN.

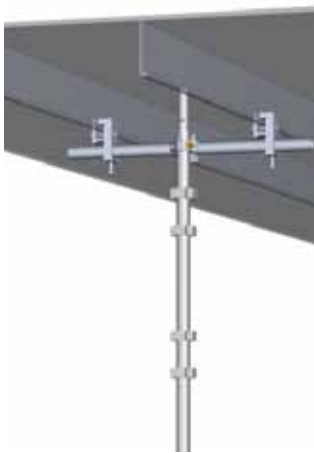

**Clamp bulb iron tube**

Designed for bulb flats (Holland profile) 160x8 mm.

Used in combination with scaffold tubes and right angle couplers.

Permissible load for device 20.0 kN. However, scaffold tubes and couplers limit the permissible load in the standard.

The device may be modified for other profile sizes.



**Suspension device grating**

Designed for gratings with minimum opening 42x16 mm and up to 80x80 mm. Can also be used in holes of at least  $\varnothing$  45 mm.

Used in combination with chain suspension device 7175001 or 7175002.

Permissible load 20.0 kN.

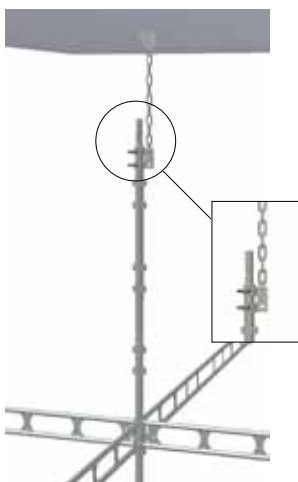









**Suspension device KF 48 double**

Used for suspension of a standard in a welding lug or similar when the chain suspension device 7175001/7175002 cannot be used. For example, when the top of the standard is occupied by another standard, when there is a large angle of deviation, or when fixing further down the standard.

Used in combination with chain with long links of type LLU 11-8 and shackle 6130251.

Permissible load 20.0 kN.

Recommended tightening torque 60 Nm, maximum tightening torque 80 Nm.

Name		Code	Item no.	Weight
<b>Suspension device Chain</b> Construction height 1362 or 850 mm Permissible load 20.0 kN		Suspension device chain 1362	<b>7175001</b>	4.3
		Suspension device chain 850	<b>7175002</b>	3.0
<b>Clamp H-beam</b> For H-beam with flange width 80-180 mm, 150-300 mm or 300-450 mm Permissible load 20.0 kN		Clamp H-beam 80-180	<b>7172100</b>	5.1
		Clamp H-beam 150-300	<b>7172000</b>	6.8
		Clamp H-beam 300-450	<b>7172001</b>	7.6
<b>Clamp L-beam</b> For L-beam with flange width 60-120 mm Permissible load 20.0 kN			<b>7176000</b>	5.3
<b>Clamp bulb iron chain</b> For bulb flats 160x9- 200x12 mm Permissible load 20.0 kN			<b>7177002</b>	2.5
<b>Clamp bulb iron chain</b> For bulb flats 220x10 - 300x13 mm Permissible load 20.0 kN			<b>7177001</b>	2.5
<b>Clamp bulb iron chain</b> For bulb flats 320x11.5 - 370x16 mm Permissible load 20.0 kN			<b>7177003</b>	3.7
<b>Clamp bulb iron tube</b> For bulb flats 160x8 mm Jaw width 22 mm Permissible load 20.0 kN			<b>7177100</b>	3.0
<b>Suspension device grating</b> Permissible load 20.0 kN			<b>7171001</b>	2.4
<b>Suspension device KF 48 double</b> Hole diameter 20 mm Jaw width 22 mm Permissible load 20.0 kN			<b>7175101</b>	2.1

